

Volume

1

FEN 101 ~ HOW TO BUILD A FENCE

Table of Contents

Chapter 1: Do I really need a fence?

Chapter 2: Hire a Professional or Do It Yourself Job

Chapter 3: What Type of Fence Should I Install (Fence Types)

Chapter 4: Tools Needed to Get Started

Chapter 5: Installing the Fence (The Specs)

Chapter 6: Additional Good Books



Do I really need a fence?

First of all, welcome to FEN 101, otherwise known as How to Build a Fence. You are about to explore the wonderful world of fence building. This how to guide will provide you with a step by step framework for creating a fence. We will look to explore everything from the initial thoughts of building a fence to the end product and maintenance. Whether you are a novice or expert fence builder you are almost guaranteed to learn or familiarize yourself with something you may not have known previously about fence building. For purposes of this book we will explore primarily how to build residential fences. Anything beyond residential fences (commercial and industrial) requires

the same basic methods as residential fences but are subjected to various government rules and regulations. Well, good luck with the project and happy fence building.

The first question you should ask yourself before you go through with building a fence is, “Do I really need a fence?” To answer this question thoroughly you will have to consider a number of things.

The first and foremost reason you may need to build a fence is to meet local government (city, town, state) rules and regulations. Many local governments require that certain types of commercial industries fence in their businesses. In addition, pool and pet owners are often required to fence in the area around their pool or animal. If this is the case then it's a given, you are in definite need of a fence in order to meet these rules and regulations. Trying to evade the government and violate local laws will only lead to troubles

and liabilities down the road. Taking proactive measures to prevent and secure your parcel from potential liabilities is a wise investment that will most likely save your trouble in the long run.

On the other hand, if it is not required by the local government your next question should be can I afford it? Although it may not be required by law to have a fence for the given parcel, your desire to enclose it may be a matter of aesthetics. When this is the case you simply need to recognize financial concerns. If you can afford it and have discussed the idea with your family then by all means you should go for it. However, if you find yourself in financial trouble and don't really have any real need for the fence other than to beautify your parcel then you may want to reconsider building a fence.

Hire a Professional or Do it yourself.

For the most part this book will entail details on the “do it yourself job” of fence building. However, considering whether a professional is needed should be a serious consideration. You may need to consider hiring a professional if you are on a strict timeline or the project is just too large for you to do yourself in a reasonable amount of time. Nonetheless, getting yourself involved with a fence project only to find out a week into you are over your head is a real concern.

Now you are probably thinking, “What’s the big deal, if I start it and realize I’m in over my head then I’ll just hire out, they will pick up where I left off and all will be fine.” Well,

only the end result of the project being fine is agreeable. Starting a project and deciding that you need to hire out half way in will often result in a greater financial, time, and labor loss. For example, suppose you decide that you want to install about 2000 feet of aluminum fence over the course of a month with intentions of a having installing a pool by July. In addition, you realize that you are budgeted in order to afford the pool you plan to install in the upcoming months. You go to the local stores, shop around and find the best materials at the most reasonable costs. At the start of the fence project, day 1, you have all the necessary materials and appropriate project outline for the fence. Your drawings call for one fence post every 6 feet dug approximately 3 feet deep with crushed stone surrounding the base. You pull out your post hole digger and immediately jump into the project. At the end of day one you have finished installing 25 fence posts and have spent a little over 8 hours on the project (assuming

each fence post you installed from digging to backfilling took only 20 minutes non-stop.) At the start of day two your back is hurting, hands are blistered, and overall your body just feels spent. As a result, you take a day off and continue day two on what would have been day three. After a week passes you have successfully installed 150 posts (basically setting the ground work for 1500 feet of fence) continuing the format used on day one. Now your week long vacation is up and your regular job resumes Monday. With only three weeks left until you anticipated on installing your fence you realize at this rate you will not be able to finish the project simply working on the weekends and you can't afford to take any more time off from work. As a result you decide to hire professionals to get the job done for you.

After calling the professionals you are excited to find out that they can install 2000 feet of fence in less than two weeks. However, in order for the company to warrant there

fence installation they refuse to use the materials you bought and will only install fence fabric on posts the company has installed. Now you are out a week's vacation, hundreds of dollars in supplies, and countless hours spent attempting to do it yourself. In addition, you now have to pay the professionals for their labor and materials.

Essentially, this may never actually end up happening. However, the point is to be aware that many companies will not accept labor or materials purchased from other vendors including yourself. The professionals often carry warranties with their fence installations and will not assume the liability involved with continuing work that is not originally their own.

Fence Types

Before deciding on what type of fence to install you must consider a number of different factors. Are you in need of privacy? Do you need a place for your dog to run free without getting into trouble or danger? Are your children able to play in a safe place without you worrying about strangers or traffic? If you own a pool, have you met government regulation and more importantly limited your potential liability? Or, maybe you feel your yard needs a little something extra to give it an architectural edge. Nonetheless, this section of the book will help you determine which type of fence is right for you.

The initial step is to decide whether the fence is to be for a swimming pool or other miscellaneous residential purposes. The following are possible reasons for needing to erect a residential fence assuming appearance is the most important attribute:

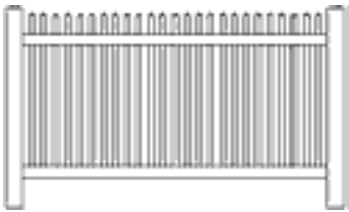

Aesthetic Landscaping:

Vinyl Classic Picket - Straight Top

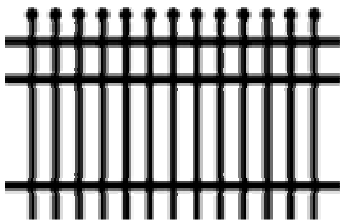

Aesthetic Landscaping (cost effective):

Residential Aluminum Delgard Avalon Style

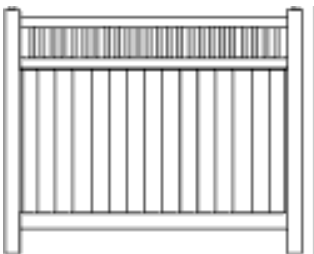

Privacy:

Vinyl Tongue & Groove Privacy with Closed Spindle



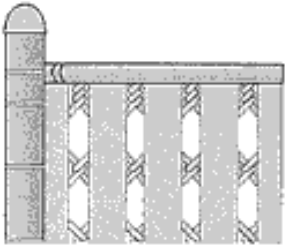

Privacy (cost effective):

Residential Chain Link (Galvanized) with Slats

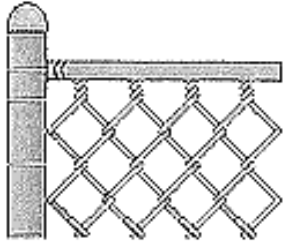

Contain Animals or Small Children (cost effective):

Residential Galvanized Chain Link

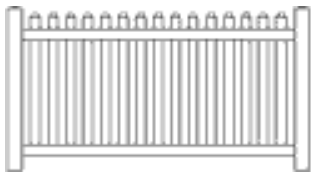

Identify Property Boundaries:

Vinyl Contemporary Picket - Straight Top

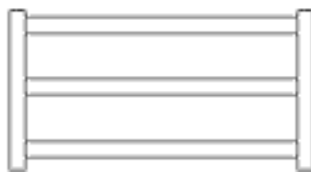

Identify Property Boundaries (cost effective):

Ranch Rail

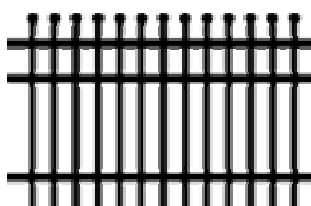

Protect Property from Animals and Unwanted Guests:

Commercial Delgard Madrid Style



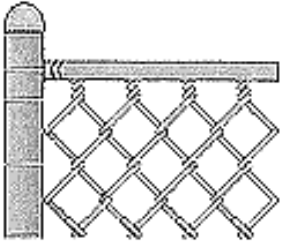

**Protect Property from Animals
And Unwanted Guests (cost effective):**

Residential Galvanized Chain Link

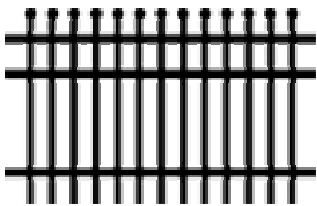

Restrict Access to Unwanted Strangers:

Commercial Delgard Madrid Style

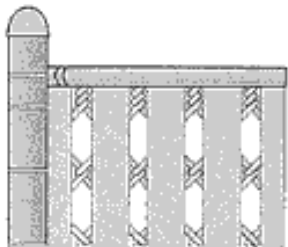

Restrict Access to Unwanted Strangers (cost effective):

Residential Galvanized Chain Link



Tools

This section will outline the tools and materials needed in order to carry out your fencing project. A wide array of tools may be used in order to get the job the done to fit any budget. The following is a list of tools and materials needed in order to construct a fence:

All Fences

Costlier but More Efficient:

- Power Saw
- Machine Post Hole Digger
- Steel Tape Measure
- Marking Pencil
- Hammer
- Work Gloves
- Ultra Laser Level
- Ready Mix Concrete
- Tamping Rod
- Wooden Stakes & Nylon Line

Cheaper but Less Efficient:

- Jig Saw or Hacksaw
- Mechanical Post Hole Digger
- Plastic Fabric Tape Measure
- Marking Pencil
- Hammer
- Work Gloves
- Standard Level
- Gravel, Crushed Stone, or Sand
- Tamping Rod
- Wooden Stakes & Thin Rope

Now depending on the exact type of fence you are looking to construct you will find the specific materials will vary from project to project. Wooden fences will require wooden posts and boards in addition to a nails, wood chisel, preservative, paint, and stain. Aluminum fence will require aluminum posts, aluminum fabric, wire ties, aluminum post caps, and wire cutters.

Many steel and vinyl fences are likely to come pre-assembled for the most part and will only require you to dig and set the fence posts. In addition, you will need to properly connect each segment of the fence together. Many of these fences comes with small tags with specific instructions on how exactly the fence should be connected.

One other “tool” you may need is a building permit. Make sure to check with your town clerk to verify the need for a permit. Also, be aware of any state or local codes to

that may apply to your project. Violating any laws and statues will almost guarantee you unnecessary headaches down the road. Lastly, be sure to follow all safety precautions and warnings associated with the type of fence that you are installing.

Once you have determined the height you would like or are required to build your fence you will need to purchase materials. The following is a general guide to determining the amount of material needed for each type of fence:

	Wood	Aluminum	Vinyl
Pickets/Fabric	6'	6'	6'
Posts	8-9'	Pre-Assembled to Posts	Pre-Assembled to Posts
Pickets/Fabric	10'	10'	10'
Posts	12 – 13'	Pre-Assembled to Posts	Pre-Assembled to Posts

Installing the Fence

This is the most important part of the entire book. Properly installing your fence will make all the difference in the end. Rushing any portion of the project could lead to unwanted effects down the road. For purposes of simplicity this section is broken up step by step with applicability for each type of fence.

Step 1: Laying Out the Fence Line

Decide exactly where you want your fence to be placed. Wooden stakes should be placed

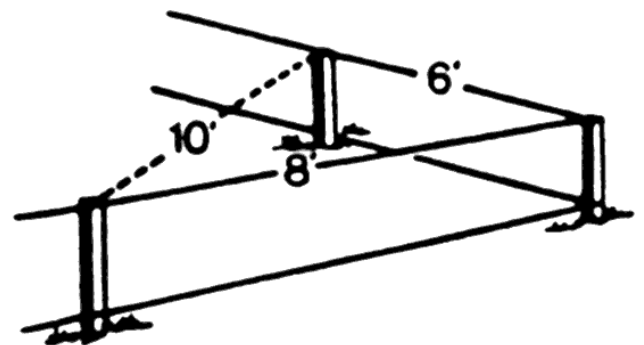

approximately where you would like the fence posts to be dug, however, at this stage it not required. Run string along the outside of the proposed fence attaching it to each stake you have placed into the ground. To ensure near perfect right angle corners you should use the pythagorean method for fencing. Measure six feet away from the corner in one direction and eight feet in the other direction. Take the square root of the sum of each number squared together to get a value of ten feet ($\sqrt{(6^2 + 8^2)} = 10'$.) Creating a 6, 8, 10 triangle will guarantee that right angles are formed at every corner.

Step 2: Treating Posts

This step primarily relates to wooden fences. Aluminum and vinyl fences do not warp or rot in the same fashion as wooden fences do. Vinyl fences are made from plastics and do not rust or rot. Aluminum fences tend to be

made from aluminum and steel. Aluminum by itself does not oxidize and rust. Steel on the other hand will over time. As a result, these types of fences come galvanized to protect against rusting.

If constructing a wooden fence, pressure treated fence posts should purchased. If this is not an option then purchase the appropriate lumber and then coat the wood with the proper water sealant. Avoiding this step could lead to a very short life span of your fence. Wood that is left untreated will rot and warp over time creating a very unsightly and weak fence.

Step 3: Proper Post Spacing

For aluminum and wood fences a general rule of thumb is not to exceed 10 feet between fence posts. Overtime, wood fences that have excessive gaps between fence posts will end up sagging and turn into an unsightly mess. When

approaching corners the same fence post spacing should be used. However, you may shorten the distance if desired for better appearance. In addition to creating proper post spacing, make sure to factor in room for gates. The average man gate is about 4 feet wide. The size of the gates is entirely up to the builder.

Digging the Posts:

To properly dig fence posts you must consider the three difference kinds of fence posts: line posts, gate posts, and corner posts. Line posts are subjected to less stress than both gate and corners posts. As a result line posts holes need not be dug as wide as gate or corner posts.

Generally, about one third of the fence post should be below ground. In addition, you should dig approximately 6 inches deeper than necessary to leave room for gravel fill at the base of the posts. This will create the strongest fence

posts with minimal settling and shifting. The diameter of the line fence posts should range anywhere from 3 to 6 inches beyond the diameter of the posts. Obviously the larger in diameter, the more support the post will have. For small wood fence projects anything more than 3 inches for line fence posts is not required. On the other hand, gate and corner posts should be more around 6' beyond the diameter of the fence post to provide additional support for stress. Aluminum fence posts are often subjected to more weight and may need extra support at the base for each line fence post.

Step 5: Setting the Posts

The fence posts should be set on top of approximately 6 inches of gravel and surrounds entirely by ready-mix concrete. Ensuring the post is below front line will help prevent against frost heaving. All fence posts should be

centered in the post holes dug. The use of a plumb line or level will be necessary in order to ensure is vertical while filling in the hole. To add extra support to corner posts, you may choose to nail cleats to the bottom of the posts. Lastly, slope the surface of the fill away from the fence posts to avoid water settling on the fence posts.

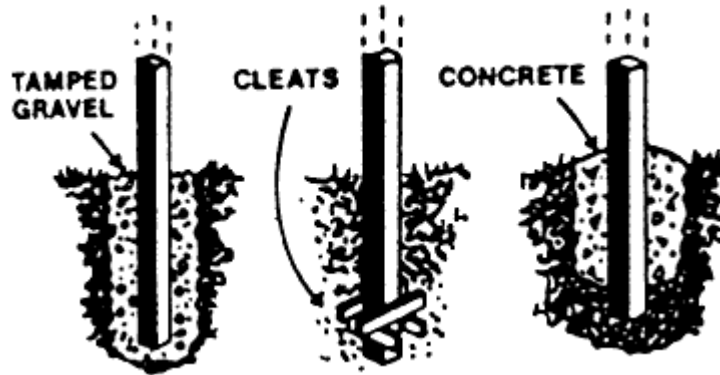

Step 6: Attaching the Rails and Boards

After allowing approximately 24 to 48 hours for the concrete to set you may set the fence rails.

The bottom rail should be placed about 6" above the ground to avoid

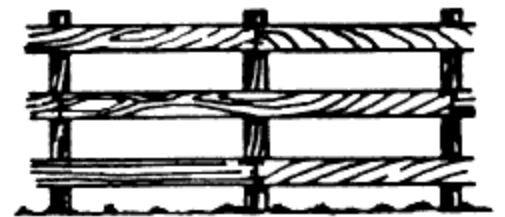

ground moisture. Make sure that both ends are the same

height off the ground. Both top and bottom rails should be parallel with each other. If creating a picket fence, fasten each picket appropriately creating a nice even and level row of pickets. The above is a picture of a standard three rail fence. The only difference between a three rail fence and a picket fence is that the three rails are covered up by pickets. If you encounter any type of hills in your fence project you should build it in a step method or follow the contour of the ground.

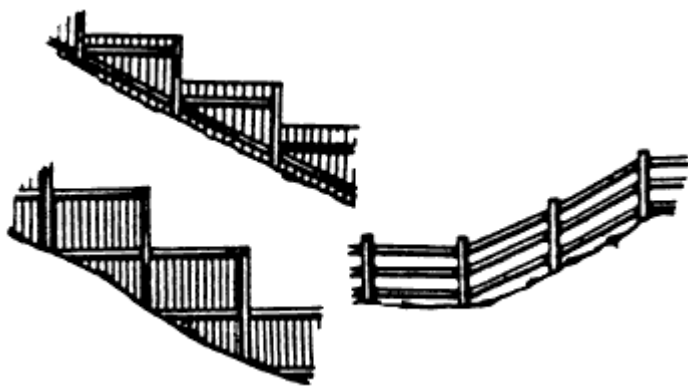

Step 7: Installing Fence Gates

Gate openings should be at least 3' but preferably 4' wide. Fence posts should be found on the both sides of the gate.

The gate itself should have lapped corners and diagonal braces to create strength and firmness.

Allow for 1" of room between the frame

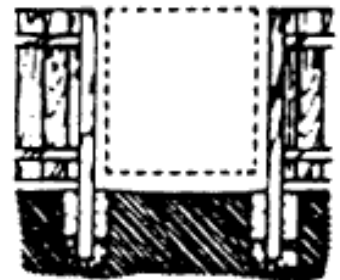

of the gate and the distance between the inside of the two gates posts to ensure the gate can swing freely. After the gate has been constructed properly for the space desired, attach the hinges and gate latch. If you desire a stop, nail a piece of fencing material to the latch post.

Additional Good Books

- 1) **Building Fences of Wood, Stone, Metal, and Plants**
by John Vivian
- 2) **Building Bamboo Fences** by Isao Yoshikawa
- 3) **Fences & Gates : Plan, Design, Build** by Editors of
Creative Homeowner
- 4) **Ortho's All About Fences and Gates (Ortho's All
about)** by Larry Johnston
- 5) **Fences for Pasture & Garden** by Gail Damerow